



Real Time Gas Pipeline Leakage Detection, Prevention And Notification System

G. Shubha, Ashish Arya, Ashish Kumar, Chandranshu Mishra,
Himanshu Singh

Department of E & C

Siddaganga Institute of Technology, Tumakuru
Visvesvaraya Technological University, India

Date of Submission: 22-02-2021

Date of Acceptance: 06-03-2021

ABSTRACT: Gas pipelines play a very important role in the transportation of gas in cities and industries which is one of the major factor in the growth of an economy. Leakage in gas pipeline can cause a lot of socio-economic losses due to fire as well as environmental hazards. To overcome these losses and eliminate hazards, a real time gas leakage detection, prevention and notification system has been designed and developed. In real time gas pipeline leakage detection, prevention and notification system, sensors are placed between two points (nodes) along the pipeline to measure various parameters viz. the temperature, pressure, weight and type of gas. Continuous wireless monitoring of the sensors is done in real time using IOT. Whenever there is an abrupt change in the parameters, a leakage can be detected with high reliability. In case a leakage is detected, the flow of gas will be instantly shut off by using a solenoid valve. The concerned authorities are alerted about the leakage via a mobile application and social media can also be used to ensure prompt redressal.

Keywords—Gas leakage, Notification, Sensors, Solenoid valve, Raspberry pi

I. INTRODUCTION

Gas pipes used for domestic purpose or commercial purpose play very important roles in cities, industries and thus in growing economies. But gas pipelines are also prone to leakage due to various environmental factors, which leads to gas leakage. Real time gas pipeline leakage detection, prevention and notification system proposes an innovative concept that can detect leakages and prevent any accident which arises due to leakage of gas through pipeline[1].

Gas leakages lead to loss of life as well as capital as they lead to fire accidents [2]. This led to the design and development of Real time gas pipeline leakage detection, prevention and

notification system" in order to make gas pipelines more secure.

The objectives of Real time natural gas pipeline leakage detection, prevention and notification system are:

- (i) To design and develop a real time system to detect gas leakage in pipelines.
- (ii) To prevent any hazard which may arise due to gas leakage in the pipeline.
- (iii) To notify the concerned authorities about the leakage in gas pipeline.

The paper is structured in the following way. Literature survey is discussed in section II. The block diagram description is given in section III. Interfacing of components to the Raspberry pi is discussed in section IV. Software details are explained in section V. Section VI deals with the analysis of experimental results obtained and conclusion is done in section VII.

II. LITERATURE SURVEY

A. Existing gas management system

A survey of existing gas management network is done in [6]. In this system the pipes are placed 1.5 meters below the ground. These are 6.4 mm underground steel pipes which have a lifetime of 7-10 years. The current system for the installation makes sure that all of the pipes are checked for any cracks and damage. The natural gases are odorless. So odorization box is installed. These boxes have sole purpose of adding smell to the gas in order to improve its detection. Pipes are made to withstand a load of 46 kilograms, tested for a load of 76 kilograms and operated at a load of 19 kilograms. Sacrificial anodes are used to protect the pipeline from corrosion. There is a very large surge current which forms due to the bulk of gas moving along the metal pipes. These electrical surges are removed by placing IJ boxes. After installation of the pipelines, for detection of any leakage in pipelines a



DRS box (District Review System) is installed at every 1.5 kilometers. It monitors the gas pressure along the pipeline. There are also valves present which are used to squeeze the section of pipeline which has a leakage. The major drawback is that for small leakages continuous manual monitoring is necessary such that if there is any leakage, large amount of gas will be wasted till it gets repaired manually.

B. Approaches for leakage detection

An internet of things based gas leakage monitoring and alerting system with MQ-2 sensor is proposed in [3]. Many gas pipeline leakage detection kits have been designed and are currently in use. Most of the systems consists of two blocks, a detection block and a notification block. Most of the kits do not have a failsafe in case leakage is detected. Also, they do not have automatic monitoring or off_site monitoring of pipeline statistics. A pipe inspection robot for leakage detection is proposed in [4]. Microcontroller based systems are inherently slow due to fact that programs written in C are executed sequentially. In case of gas leakages, time is off the essence, thus a slower system or a faster system with no automatic monitoring or fail safes is not acceptable. This work aims to provide real time statistics of a pipeline to the concerned authorities via the cloud to help in the off_site monitoring of the pipeline. Comparing with the works carried out so far and detection kits available in the market, this work is different as it contains Raspberry Pi which is interfaced with a number of sensors viz temperature, pressure, weight and gas sensor.. Monitoring data from multiple sensors ensures that data received is reliable and it reduces the chances of false detections. The Raspberry pi sends live data on server which can be accessed through a web UI. This enables the engineers and the maintenance workers to monitor the statistics for a pipeline. An LPG detection system using UTLP kit and GSM module for detecting leakage is proposed in [5]. By continuous and constant monitoring of pipeline statistics, the health of a pipeline can be gauged, and an impending leakage can be prevented. Previous works only sound an alarm in case a leak is detected and send an SMS to the concerned people. In case leakage is detected, this work will sound alarms, send notification about this via the web UI, also send SMS and email to concerned people along with the location of the leak. Thus, by sending the location of the pipeline where the leak has been detected, it makes it easier and faster for the concerned authorities to find and fix the pipeline. It

also prevents the leakage by closing the portion of pipeline where leakage has been detected. It is essential to shut off the flow as by the time the concerned authorities act, the already leaked gas can wreak havoc.

After analysis of previous systems and proposed solutions, it can be concluded that there is scope for improvement in the existing system. It can be observed that the pressure is the main parameter taken into account which is monitored in the gas pipeline. It is the main parameter which is taken into account. But in this paper, along with pressure sensor, other sensors such as temperature, humidity, weight and gas sensors are also used to effectively verify whether leakage is present or not.

III. SYSTEM OVERVIEW

System overview of Real time gas pipeline leakage detection, prevention and notification system is discussed in this section. The block diagram representation is shown in Fig 1.

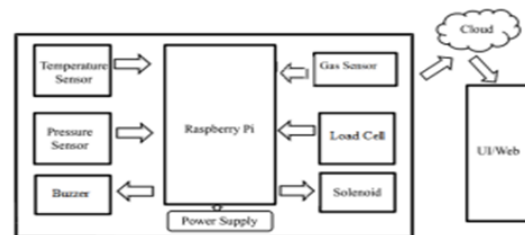

Fig 1: Block diagram of Real Time Gas Pipeline Leakage Detection, Prevention and Notification System

It consists of a Raspberry pi, temperature sensor, gas sensor, pressure sensor, weight sensor, solenoid and a buzzer. The micro controller used is Raspberry Pi. This controller is interfaced with all the sensors.

A. Flow Sensor

A flow sensor (pressure sensor) is a device used to measure pressure of gases or liquids. The pressure sensor used here is YFS-201. It is used as one of the internal sensor in our project. It is used to calculate the flow of gas in Liter/min. The flow of gas is from 5-7 Liter/min which is being updated continuously on the cloud. It is one of the main parameter to verify the leakage in pipeline when flow decreases from certain threshold (5 Liter/min is the threshold considered in this paper).

The calibration graph for the flow sensor (YFS201), was obtained by measuring the counts vs the flow measurements based on the data available from the data sheet and by passing a known amount of gas. This is shown in Fig 2.

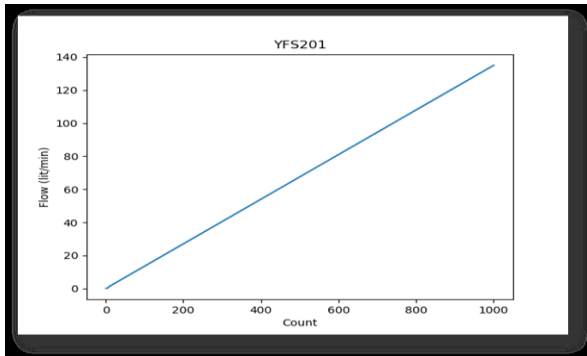

Fig 2: Calibration curve of flow sensor

Flow of the gas is calculated by using eq(1).

$$\text{Flow} = (\text{count} * 60 * 2:25)/1000 \quad (1)$$

The linear nature of the graph in Figure 2 demonstrates the linear dependence of the flow on the count, i.e. the number of rotations of the flow sensor. An increase in count signifies an increase in the flow of the gas inside the pipeline and vice versa.

Threshold : To calculate the threshold value for the flow sensor, gas was passed through the pipeline and various holes of different diameters were used to calculate the flow of the gas in case of a leakage represented by the holes. The different flow values for different holes were noted as below.

- 1cm = .810 litres/min
- 2cm = 1.48 litres/min
- 2.5cm = 1.86 litres/min
- 3 cm = 2.285 litres/ min

The average flow was 1.533 litres/min. The normal gas pipeline flow is 6 litres/min. Therefore, a value which is greater than the average flow but less the normal flow was selected at 4.6 litres/min for quick detection of any leakages.

B. Load Cell

A load cell is a transducer that is used to create an electrical signal whose magnitude is directly proportional to the force being measured. The load cell used is a strain gauge based. By measuring the weight of the pipeline when gas is flowing without leakage and comparing the weight of the gas pipeline when there is leakage, a leakage in pipeline can be reliably detected.

The calibration graph for the load cell (CZL601) was obtained at room temperature and humidity by setting a reference at 1 kg and then measuring the weights for other known weights. This is shown in Fig 3. The linear nature of the curve ensures that the weight measured by the load cell is the same as the actual weight within the acceptable margin of error.

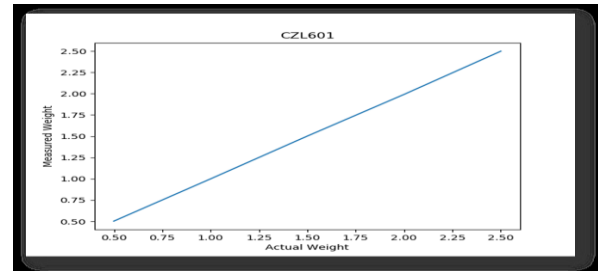

Fig 3: Calibration curve for load cell

C. Temperature Sensor

These sensors are very basic and slow, but are great for basic data logging. They are made of two major parts- capacitive humidity sensor and thermistor. There is a basic chip that does major analog to digital conversion and gives a digital signal with the temperature and humidity as the output. The digital signal is simple to read using any microcontroller. Pins used in this sensor are ground, Vcc, output pin (GPIO27). Its circuit diagram is given in Fig 4. DHT11 is also one of the internal sensor is used in this paper. This sensor will give temperature and humidity percentage in the pipeline. After passing the gas there is drastic decrease in humidity percent i.e. 30-45 % to 7% and temperature will decrease in few degrees. This DHT11 sensor is used for monitoring purpose of gas pipeline and which can be seen in the Figs 10, 11 and 12. This data was being regularly updated.

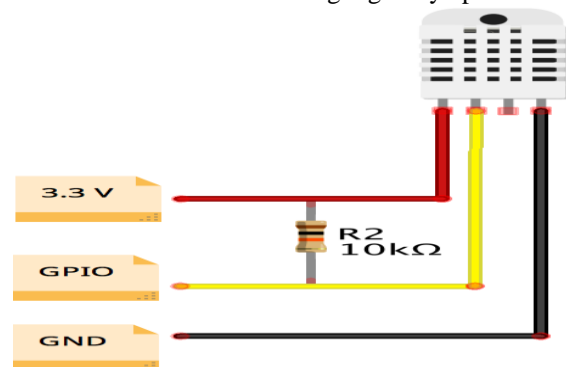

Fig 4: Pin diagram of Temperature Sensor (DHT11)

The calibration curve obtained for DHT11 sensor is shown in Fig 5.

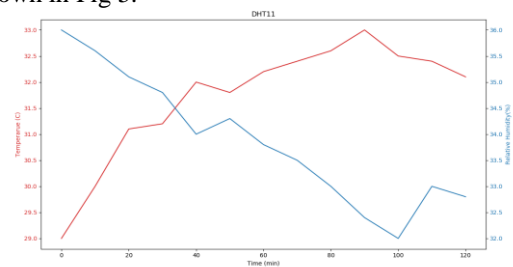

Fig 5: Calibration curve for Temperature Sensor



In order to calibrate the sensor, there are certain steps to be followed. The temperature and humidity sensor (DHT11) calibration graph was attained by keeping the temperature sensor in normal condition for two hours and noting the values in a csv file every 20 minutes. From the calibration curve, it can be noted that temperature in the starting is 29°C and it keeps on increasing as the time passes. But for humidity, initial value is 35% and it decreases gradually. So it can be concluded that temperature and humidity are inversely related.

D. Gas Sensor

A gas sensor detects the presence of gases in an area, often as part of a safety system. This type of equipment is used to detect a gas leak or other emissions and can interface with a control system so that a process can be automatically shut down. A gas detector can sound an alarm to operators in the area where the leak is occurring, giving them the opportunity to leave. This type of device is important because there are many gases that can be harmful to organic life, such as humans or animals. Analog gas sensor MQ2 is used. It is used in gas leakage like smoke methane and liquefied flammable gas. It has a wide detecting scope, fast response and high sensitivity. Simple drive circuit, stable and long life. It can detect LPG, i-butane, propane, methane, alcohol, hydrogen and smoke[1]. The pins used are ground, Vcc and digital output pin(gpio21). It is shown in Fig 6. MQ2 is the gas sensor used as an external sensor in this paper. This sensor will detect the gas whenever leakage occurs in the pipeline. However the range of the MQ2 sensor is less i.e. around 60cm and it can detect gases such as LPG, butane, smoke, etc.

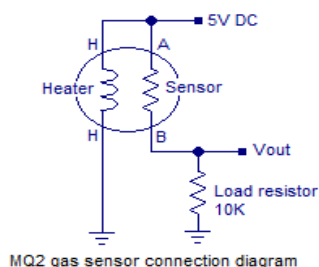

Fig 6: Circuit diagram of Gas sensor

The calibration curve obtained for MQ2 sensor is shown in Fig 7. The calibration graph for the gas sensor (MQ2) was obtained at room temperature and humidity by sequentially increasing the number of incense sticks lit one at time and noting the values in csv file.

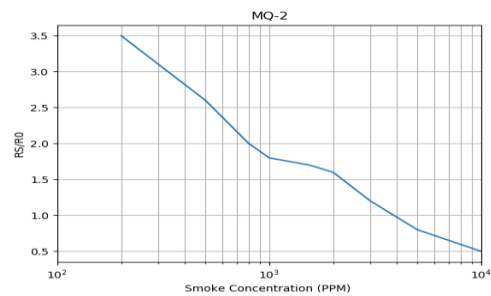

Fig 7: Calibration curve for MQ2 sensor

When values from the gas sensor are plotted against concentration of the gas (smoke) used, it shows to be a decreasing curve. On y-axis, R_s/R_o is plotted and its values keep decreasing with increase in the temperature. where,

R_o is resistance variable for fresh air
 R_s is resistance variable for the smoke

E. Solenoid Valve

A solenoid valve is an electro-mechanical device. In this device, a solenoid uses a current to generate magnetic field. This field is then manipulated so that the valve could operate. This valve regulates the flow of fluids through the gas pipeline. In case a leakage is detected due to variation in any of the parameters viz. temperature, humidity, flow, weight, gas detection, the constant flow of electric current is stopped due to which electromagnetic field disperses hence solenoid valve gets turned off to stop the flow of gas in the pipeline.

IV. INTERFACING

The interfacing details of Real time gas pipeline leakage detection, prevention and notification system is discussed here. It is shown in Fig 8.

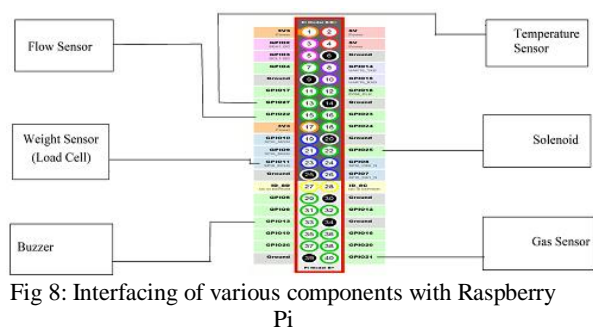

Fig 8: Interfacing of various components with Raspberry Pi

Each component is connected to Raspberry Pi via GPIO pins. The list of connections is as follows:

- Vcc and Gnd are connected to all sensors from pin 2 and pin 6 of Raspberry Pi respectively.



- Flow Sensor (Vout): GPIO 22
- Load Cell (Gout): GPIO 11
- Gas Sensor (Dout): GPIO 21
- Temperature Sensor (Dout): GPIO 27
- Solenoid (+ pin): GPIO 25
- Buzzer (Din): GPIO 13

V. SYSTEM SOFTWARE

A. Software Requirements

All the different softwares and applications which are used in this work are discussed here.

Python: Python is a high level general purpose programming language used for programming Raspberry Pi.

Thingspeak: It is an IoT application. It stores and retrieves data sent on the cloud. It uses HTTP protocol. It enables the live tracking of the sensor data. Four plots are designed in order to monitor data sent by the sensors. It helps in better representation of data as a scatter plot of all the data.

Android: Android is an open source mobile operating system. It is used to monitor real time sensor data and also to give notification if leakage in the pipeline occurs.

MQTT Protocol: It is a headless transmission protocol used in IOT devices. The Raspberry Pi and the Android application communicate with each other through MQTT protocol.

B. Flowchart

The flow chart for Real time gas pipeline leakage detection and prevention system is given in Fig 9.

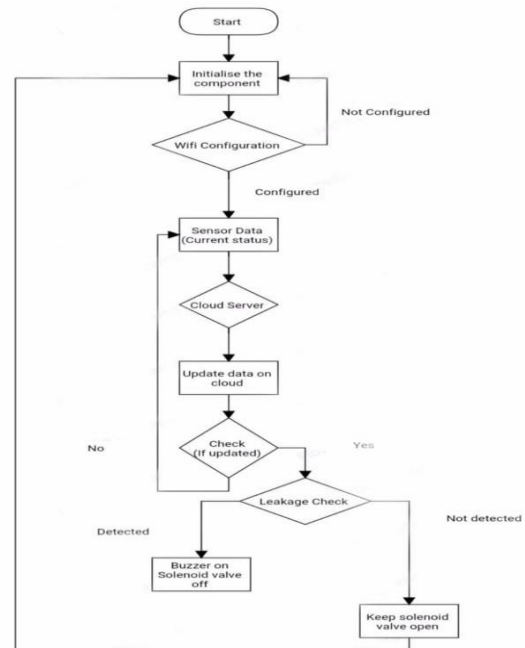

Fig 9: Flow diagram of Real time gas pipeline leakage detection, prevention and notification system

All the components are initialized. The WiFi configuration is checked to ensure the system can send the data to the cloud and the android application. If WiFi is not configured, wait until it is configured else send the data from the various sensors viz. temperature and humidity sensor, flow (pressure) sensor, gas sensor and load cell to the cloud and the android application. Compare the current values and the previously defined threshold values. If the values are not in accordance with the threshold values, i.e. a leakage is detected, the solenoid valve is closed to stop the flow of gas and a buzzer is used to notify nearby people of the leak and also a notification is sent on the android application. In case the values are in accordance with the threshold values, i.e. a leakage is not detected, the solenoid valve remains open and the above mentioned process is repeated.

VI. EXPERIMENTAL RESULTS

This section shows the model of a simple, user-friendly, secure, low cost and universally accepted solutions for safety of gas pipeline. Gas, weight, temperature, humidity and pressure sensors are interfaced with the microcontroller. Once, any abrupt change occurs in any sensor readings, the system considers this as a leakage. To prevent any disaster caused, a solenoid valve closes the cross section of the pipe. The notification about this is sent in twitter via cloud.



Snapshot of the Real time gas pipeline leakage detection, prevention and notification system" with different components is shown in Fig 10.

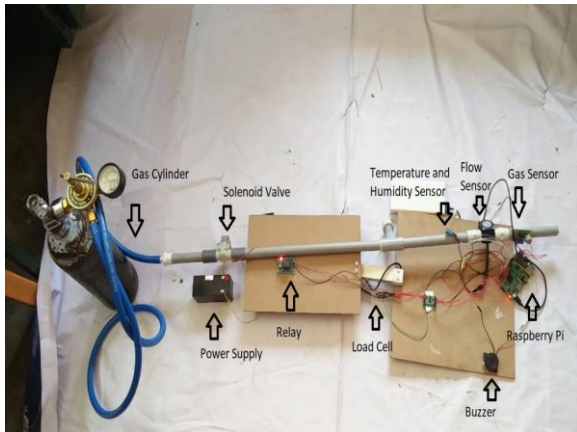

Fig 10: Snapshot of Real time gas pipeline leakage detection, prevention and notification system

The analysis of the results obtained during the operation of the project are as follows.

- No gas flows through pipeline: When no gas is flowing through the pipeline, output from each sensor can be monitored on the android application. It is shown in Fig 11.

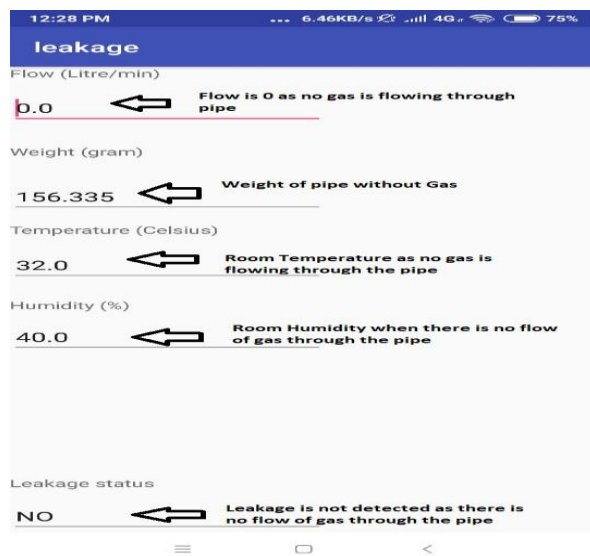

Fig 11: Monitoring gas pipeline via android application.

In Fig 11, flow sensor data shows that there is no flow of gas through pipeline. The weight of the pipeline shows the weight of the pipeline without the gas flowing through it.

A. Gas flow present through the pipeline but no leakage: When gas flows through the pipeline properly and there is no leakage present, then the readings from the sensor can be monitored on android application and on live data on thingspeak. It is shown in Figs 12 and 13 respectively.

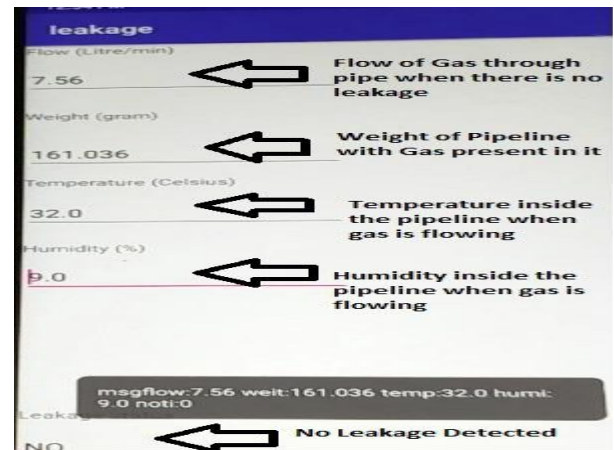

Fig 12: Monitoring gas pipeline via android application

In Fig 12, the flow sensor shows a value as the gas flows through the pipeline. There is also an increase in the net weight of the gas pipeline. The temperature and humidity in the pipeline decreases. This can also be seen through sudden spike in humidity, temperature and the flow rate as shown in Fig 13.



Fig 13: Live data monitoring via ThingSpeak

B. Leakage is present in pipeline: The notification system when leakage is present in gas pipeline via android application is shown in Fig 14.

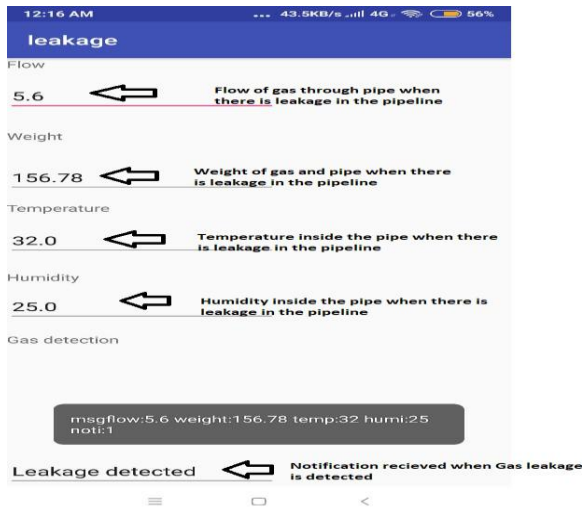

Fig 14: Notification on android application

As seen in Fig 14, the flow of gas across the pipeline is decreased. Also, weight of pipeline decreases. Gas leakage in the pipeline is detected if readings for any parameter cross a fixed threshold. The flow of gas through pipeline is stopped by using a solenoid valve. Notification regarding this is sent on the android application and in twitter. The notification system when leakage is present in gas pipeline via. twitter is shown in Fig. 15



Fig. 15: Notification as seen in twitter

VII. CONCLUSION

Gas pipelines play a very vital role in transportation of natural gas for commercial and domestic purpose. The proposed system is to provide safety feature for those gas pipelines. By making use of gas, pressure, temperature, humidity and weight sensors, accidental hazards could be avoided by using solenoid valve. This system consists of three major parts- detection, prevention and notification. The sensors are calibrated in such a way that when any sudden change is detected, it considers it as a leakage and closes the cross section of the pipe.

This work can be enhanced in number of ways. Firstly, sensors could be placed in a much more compact way. As the sensors are to be placed at fixed intervals along the pipeline, if they are placed in more compact way it would be much easier for installation of pipeline. Secondly, this work could be modified in such a way that it should locate the point of leakage much more accurately.

REFERENCES

- [1]. Shreelakshmi A, Sowbhagya H S, Srigouri C, Shravani D N, Pipe Inspection Robot", IEEE Transactions on Circuits and Systems, vol. 62, pp. 2594-2605, 2015.
- [2]. Allen Boaz, Shubi Kaijage and Ramadhani Sinda, An overview of pipeline leak detection and location systems", 13th IEEE International Joint Conference, vol. 179, pp. 1239-1240, 2016.
- [3]. Rohan Chandra Pandey, Manish Verma, Lumesh Kumar Sahu, Internet of Things (IOT) Based Gas Leakage Monitoring and Alerting System with MQ-2 Sensor", IEEE Data Compression Conference, vol. 23, pp. 1068-0314, 2016.
- [4]. Varun Kumar, Abdul Hadi Ahmed, Amit Kumar, Laxmi Chauhan, LPG Detection System using UTLP kit with GSM Module", IEEE Transactions on Circuits and Systems, vol. 62, pp. 2594-2605, 2016..
- [5]. Luay Fraiwan, Khaldon Lweesy, Aya Bani-Salma, Nour Mani, A Wireless Home Safety Gas Leakage Detection System", IEEE 15th Conference on ICT and Knowledge Engineering, vol. 12, pp.419-421, 2017.
- [6]. <http://tumkur@meghagas.com>