



# Fuzzy Logic PI Controller for load frequency control in Four Area Power Systems

Pradeep Kumar Sahu  
*M.Tech ( Power Electronics)*  
*pradeepkumar6300@gmail.com*

Date of Submission: 26-04-2023

Date of Acceptance: 06-05-2023

**Abstract-** This paper presents a load frequency control in four area power systems using fuzzy gain scheduling of PI controller is realized. The system simulation is realized by using Matlab/Simulink software. System dynamic performance is observed for conventional PI, fuzzy PI and fuzzy logic controllers.

## I. INTRODUCTION

In recent years, power systems have more complicated and nonlinear configurations. Many industrial establishments are affected by operating point variations. Electricity sector and end user are concerned about power quality reliability, efficiency and energy future. There are many reasons about increasing concerns on power quality. The microprocessor based equipments and power electronic devices are more sensitive to power quality. On the other hand, an electric network consists of many interconnected subsystems. If a fault occurs in a subsystem, disturbances and interruptions adversely affecting power quality take place in the power system. Any disharmonies between energy generation and demand cause frequency deviations. Thus, significant frequency deviations lead to system blackouts. Power system loads are usually variable so that controller system must be designed to provide power system quality. Interconnected power systems regulate power flows and frequency by means of an automatic generation control (AGC). AGC is a feedback control system adjusting a generator output power to remain defined frequency. AGC comprises a load frequency control (LFC) loop and an automatic voltage regulator (AVR) loop. LFC system provides generator load control via frequency. Zero steady-state errors of frequency deviations and optimal transient behavior are objectives of the LFC in a multi-area interconnected power system. So far there are many studies about load frequency control of interconnected power systems. The aim is a

design of feedback controller to realize desired power flow and frequency in multi-area power system.

In literature, control strategies based on conventional fuzzy and neural network controller are proposed. Several authors suggest variable-structure systems, various adaptive control techniques and Riccati equation approach for load a frequency controller design. There are many studies about different control strategies having advantages and disadvantages. A load frequency control using a conventional PID controller is applied and it is emphasized that the controller performance is better than others. However, if a power system structure has nonlinear dynamics and parts, the system operating point varies and conventional controllers needing system model must not be used. A modified dynamic neural networks controller is proposed. It is determined that the proposed controller offers better performance than conventional neural network controller. For a single area system and two area interconnected power systems, artificial intelligence techniques are proposed for the automatic generation control and the comparison is performed between intelligent controllers and the conventional PI and PID controllers. A robust decentralized control strategy is used for Load frequency control for four area power systems to obtain robust stability and better performances. Power system load frequency control is realized by fuzzy gain scheduling of PI controller.

## II. FOUR-AREA POWER SYSTEM

Power systems have variable and complicated characteristics and comprise different control parts and also many of the parts are nonlinear. These parts are connected to each other by tie lines and need controllability of frequency and power flow. Interconnected multiple-area power systems can be depicted by using circles. A simplified four- area interconnected power system used in this study is shown in Fig. 1.

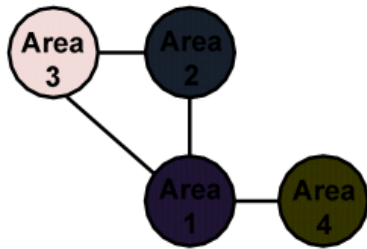

Fig. 1. Simplified interconnected power system diagram.

In Fig. 2, a four-area interconnected system block diagram is depicted. The system frequency deviation  $\Delta f_i$ , the deviation in the tie-line power flow  $\Delta P_{tie,i}$ , load disturbance  $\Delta P_{Di}$ . The system parameter values are given in Appendix. The system state-space model can be represented as

$$\begin{aligned} \dot{x} &= Ax + Bu \\ y &= Cx \end{aligned} \quad (1)$$

Where, system matrix A, input matrix B, state matrix x, control matrix u and output matrix C

$$\begin{aligned} u &= [u_1 \ u_2 \ u_3 \ u_4]^T \\ y &= [y_1 \ y_2 \ y_3 \ y_4]^T = [\Delta f_1 \ \Delta f_2 \ \Delta f_3 \ \Delta f_4]^T \\ x &= [\Delta f_1 \ \Delta P_{T1} \ \Delta P_{G1} \ \Delta P_{c1} \ \Delta P_{tie1} \\ &\quad \Delta f_2 \ \Delta P_{T2} \ \Delta P_{G2} \ \Delta P_{c2} \ \Delta P_{tie2} \\ &\quad \Delta f_3 \ \Delta P_{T3} \ \Delta P_{G3} \ \Delta P_{c3} \ \Delta P_{tie3} \\ &\quad \Delta f_4 \ \Delta P_{T4} \ \Delta P_{G4} \ \Delta P_{c4} \ \Delta P_{tie4}]^T \end{aligned} \quad (2)$$

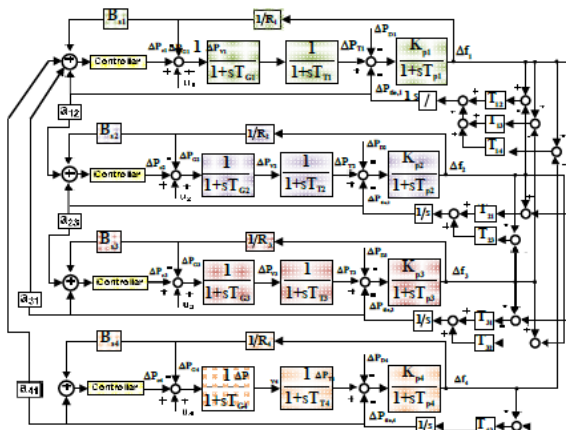

Fig. 2. Blok diagram of a four-area power system.

### III. FUZZY LOGIC CONTROLLER

Since power system dynamic characteristics are complex and variable, conventional control methods cannot provide desired results. Intelligent controllers can be replaced with conventional controllers to get fast

and good dynamic response in load frequency control problems. If the system robustness and reliability are more important, fuzzy logic controllers can be more useful in solving a wide range of control problems since conventional controllers are slower and also less efficient in nonlinear system applications. Fuzzy logic controller is designed to minimize fluctuation on system outputs. There are many studies on power system with fuzzy logic controller.

#### Fuzzy PI Controller

The block diagram of the fuzzy PI controller is shown in Fig. 3. In this figure,  $e(k)$  is the error at the  $k^{\text{th}}$  sample. The change in error is defined as

$$de(k) = e(k) - e(k-1)$$

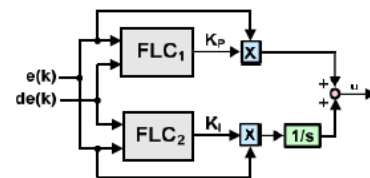

Fig. 3. Fuzzy PI controller block diagram.

FLC designed to eliminate the need for continuous operator attention and used automatically to adjust some variables the process variable is kept at the reference value. A FLC consists of three sections namely, fuzzifier, rule base, and defuzzifier as shown in Figs. 4, 5 for KP, KI and FLC, respectively.

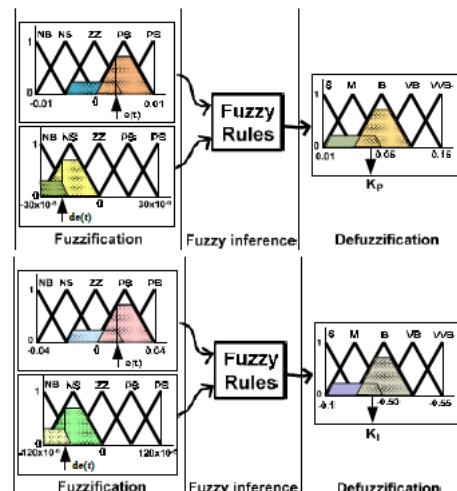

Fig. 4. Fuzzy inference system for  $K_p$  and  $K_i$ .



The error,  $e$  and change in error,  $de$  are inputs of FLC. Two input signals are converted to fuzzy numbers first in fuzzifier using five membership functions: Positive Big (PB), Positive Small (PS), Zero (ZZ), Negative Small (NS), Negative Big (NB), Small (S), Medium (M), Big (B), Very Big (VB) and Very Very Big (VVB). Triangular membership functions are used in this paper since it is easier to intercept membership degrees from a triangle. Then they are used in the rule table shown in Table I to determine the fuzzy number of the compensated output signal.

scheme. The FLC parameters are chosen on the basis of a trial and error study of the control.

TABLE I  
 FUZZY RULES DECISION TABLE FOR FLC,  
 $FLC_1$  AND  $FLC_2$

		e				
		NB	NS	ZZ	PS	PB
E	NB	S	S	M	M	B
	NS	S	M	M	B	VB
	ZZ	M	M	B	VB	VB
	PS	M	B	VB	VB	VVB
	PB	B	VB	VB	VVB	VVB

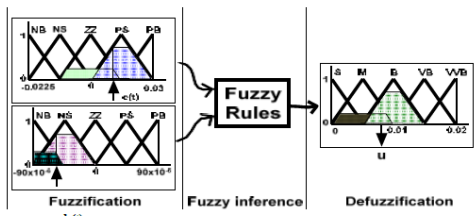

Fig. 5. Fuzzy inference system for FLC.

The main fuzzy reasoning blocks and the defuzzification process of the FLC used in this study are given in Fig. 6. The FLC used here is developed in Matlab/Simulink environment for multipurpose use as a control tool. With some simple modifications it can be used to control different systems.

Finally, resultant united fuzzy subsets representing the controller output are converted to the crisp values using the central of area (COA) defuzzifier

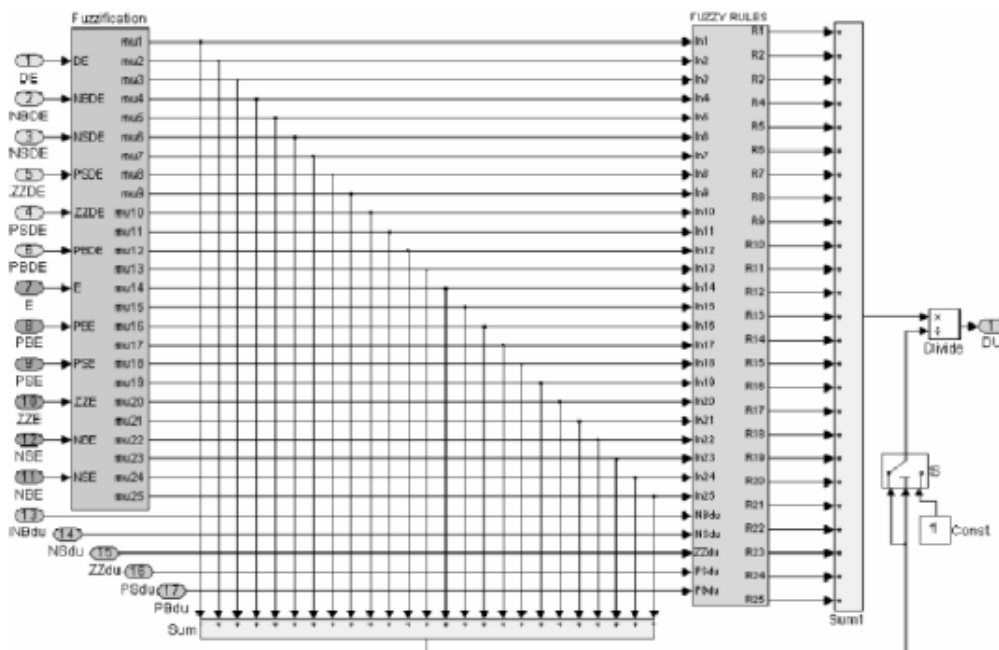

Fig. 6. the process from fuzzification to defuzzification.



#### IV. SIMULATION RESULTS

The system dynamic performance is observed for three different controller structures, PI (Proportional + Integral), Fuzzy PI and Fuzzy controller. The simulation results are shown in Figs. 7-10 in this study.

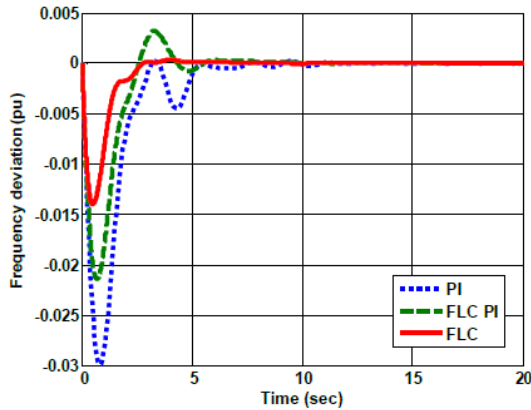

Fig. 7. Dynamic response of Area 1.

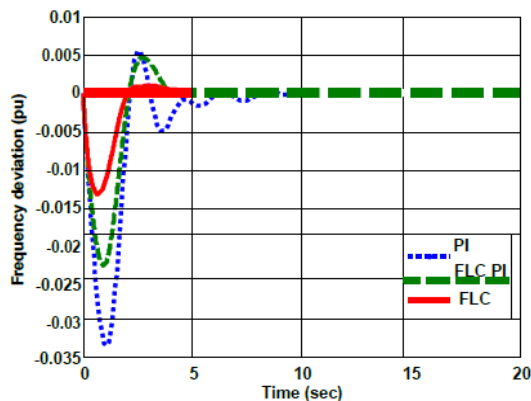

Fig. 8. Dynamic response of Area 2.

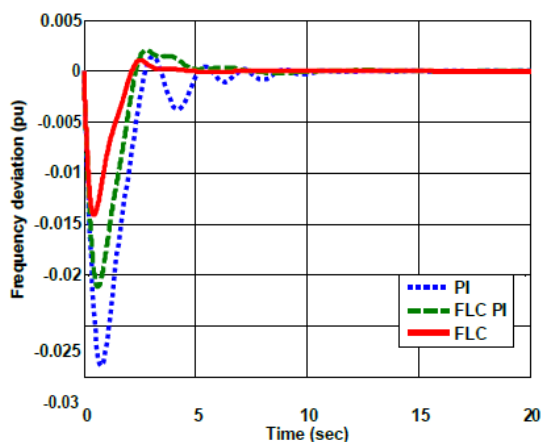

Fig. 9. Dynamic response of Area 3.

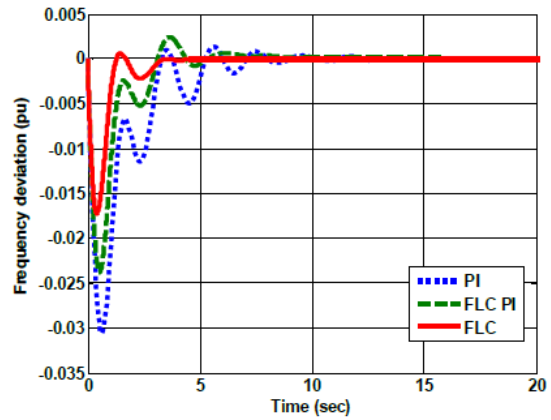

Fig. 10. Dynamic response of Area 4.

#### V. CONCLUSION

In this paper, a fuzzy logic PI controller is designed for load frequency control of four-area interconnected power systems. The system dynamic performances are observed via using different controllers & the proposed FLC controller still achieves good dynamic performance when the GRC is considered and ensures the stability of power areas for all load demand changes. The proposed FLC is more effective means for improving the dynamic performance of the two power area compared to the conventional integral controller.

#### REFERENCES APPENDIX

- [1]. C.S. Chang and W. Fu "Area load frequency control using fuzzy gain scheduling of PI controllers," *Electrical Power and Energy Systems*, vol. 42, no. 2, pp. 145-152, 1997.
- [2]. H. Cimen, "Decentralised load frequency controller design based on SSVs," *Turkish Journal of Electrical Engineering & Computer Sciences*, vol. 8, no. 1, pp. 43-53, 2000.
- [3]. H.D. Mathur and S. Ghosh, "A Comprehensive analysis of intelligent controllers for load frequency control," *IEEE Power India Conference, 10.1109/POWERI.2006.1632619*, 2006.
- [4]. H.D. Mathur and H.V. Manjunath, "Study of dynamic performance of thermal units with asynchronous tie-lines using fuzzy based controller," *Journal of Electrical Systems*, vol. 3-3, pp. 124-130, 2007.
- [5]. Y.H. Song and A.T. Johns, "Applications of fuzzy logic in power systems: part 1 general introduction to fuzzy logic," *Power Engineering Journal*, pp. 219-222, 1997.
- [6]. Y.H. Song and A.T. Johns, "Applications of fuzzy logic in power systems: part 2



comparison and integration with expert systems, neural networks and genetic algorithms,” *Power Engineering Journal*, pp. 185-190, 1998.

- [7]. Y.H. Song and A.T. Johns, “Applications of fuzzy logic in power systems: part 3 example applications,” *Power Engineering Journal*, pp. 97-103, 1999.
- [8]. I.H. Altas and A.M. Sharaf, “Novel maximum power fuzzy logic controller for photovoltaic solar energy systems,” *Renewable Energy*, 2007, doi:10.1016/j.renene.2007.03.002, 2007.
- [9]. I.H. Altas and A.M. Sharaf, “A Generalized direct approach for designing fuzzy logic controllers in Matlab/Simulink GUI environment,” *International Journal of Information Technology and Intelligent Computing, Int. J. IT&IC*, vol. 1, no. 4, 2007.
- [10]. Emre Ozkop<sup>1</sup>, Ismail H. Altas<sup>1</sup>, Adel M. Sharaf<sup>2</sup>, “load frequency control by fuzzy logic PI”, 16th NATIONAL POWER SYSTEMS CONFERENCE, 15th-17th DECEMBER, 2010
- [11]. H. Bevrani and T. Hiyama, “On load-frequency regulation with time delays: Design and real-time implementation,” *IEEE Trans. Energy Convers.*, vol. 24, no. 1, pp. 292–300, Mar. 2009.
- [12]. H. Shayeghi, H. A. Shayanfar, and A. Jalili, “Load frequency control strategies: A state-of-the-art survey for the researcher,” *Energy Con-vers. Manag.*, vol. 50, pp. 344–353, 2009.
- [13]. C. Zhang, L. Jiang, Q. H. Wu, Y. He, and M. Wu, “Delay-dependent robust load frequency control for time delay power systems,” *IEEE Trans. Power Syst.*, vol. 28, no. 3, pp. 2192–2201, Aug. 2013.
- [14]. H. Trinh, T. Fernando, H. H. C. Iu, and K. P. Wong, “Quasi-decentralized functional observers for the LFC of interconnected power systems,” *IEEE Trans. Power Syst.*, vol. 28, no. 3, pp. 3513–3514, Aug. 2013.
- [15]. Pradeep kumar sahu<sup>1</sup>, Abhijeet singh<sup>2</sup>, “Load Frequency Control with Adaptive Fuzzy Logic Approach for Multi Area Power System,” *International Journal of Science and Research (IJSR)*, Volume 4 Issue 12, December 2015.
- [16]. S. Saxena and Y. V. Hote, “Load frequency control in power systems via internal model control scheme and model-order reduction,” *IEEE Trans. Power Syst.*, vol. 28, no. 3, pp. 2749–2757, Aug. 2013.

## APPENDIX

<b>Area-1</b>
$T_{p1}=20\text{sec}, K_{p1}=120, T_{T1}=0.3\text{sec}, T_{G1}=0.08\text{sec}, R_1=2.4$
<b>Area-2</b>
$T_{p2}=25\text{sec}, K_{p2}=112.5, T_{T2}=0.33\text{sec}, T_{G2}=0.072\text{sec}, R_2=2.7$
<b>Area-3</b>
$T_{p3}=20\text{sec}, K_{p3}=125, T_{T3}=0.35\text{sec}, T_{G3}=0.07\text{sec}, R_3=2.5$
<b>Area-4</b>
$T_{p4}=15\text{sec}, K_{p4}=115, T_{T4}=0.375\text{sec}, T_{G4}=0.085\text{sec}, R_4=2$
$T_{12}=T_{13}=T_{14}=T_{21}=T_{23}=T_{31}=T_{32}=T_{41}=0.545$
$T_{24}=T_{34}=T_{42}=T_{43}=0$
$K_1=K_2=K_3=K_4=0.6$
$B_{S1}=B_{S2}=B_{S3}=B_{S4}=0.425$
$a_{12}=a_{41}=a_{23}=a_{31}=-1$
$K_{IPI}=-0.5, K_{PPI}=0.05$
$T_T$ : Turbine time constant, $T_G$ : Governor time constant, $T_p$ : Power system time constant, $R$ : Regulation parameter, $K_p$ : Power system gain, $T_{12}$ : Synchronizing coefficient, $B$ : Frequency bias parameter, $P_D$ : load disturbance, $K_i$ : Integration gain